

Featherlite[®]



Office Workstations **Edge**



50
YEARS
Work Better
Live Better

Edge

Over the rest

Featherlite presents edge workstations, designed to suit all your office needs. The edge concept is as flexible as your organisation, as components can be added as your business grows.

Quick Ship

Efficient delivery of products within 14 days of placing the order.

Best Prices

Economical and reasonable pricing of world class quality products.

Highly Modular

Readily available modular furniture to suit every office space.

Easy Installation

Quick to assemble and easy to maintain quality products.

One Stop Office

Complete range of furniture that your office needs is here.

Flexible Form

Change, rearrange recreate your office space, as and when you wish.

Simple to Relocate / Upgrade

Easy portability and convenient to reassemble.

Contemporary Design

Modern and innovative designs that evolve out of your need.

Sturdy and Solid

A result of high quality raw materials and intelligent engineering.

Inherent Cabling

In built electrical and data wiring capability.



Linear



Non Sharing

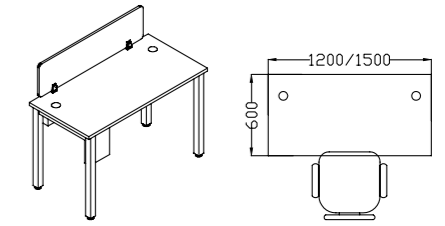

1 Seater
1200x600 / 1500x600

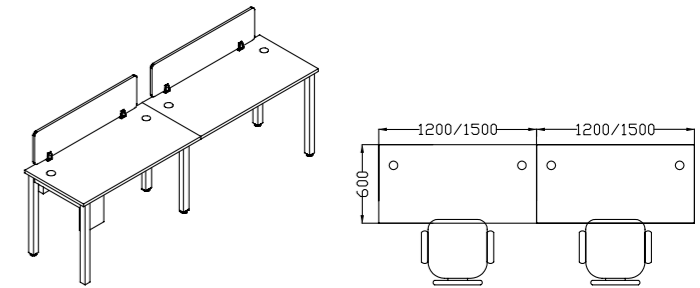

2 Seater
2400x600 / 3000x600

Sharing

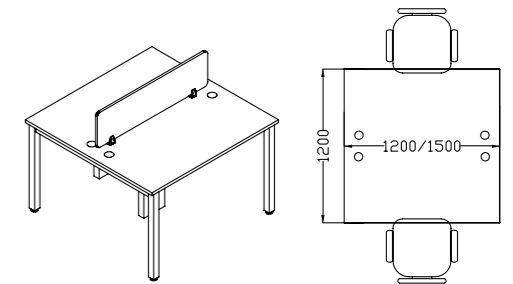

2 Seater
1200x1200 / 1500x1200

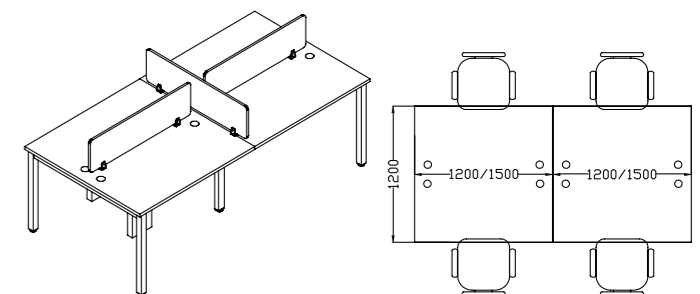

4 Seater
2400x1200 / 3000x1200

L - Shape



Sharing Cluster

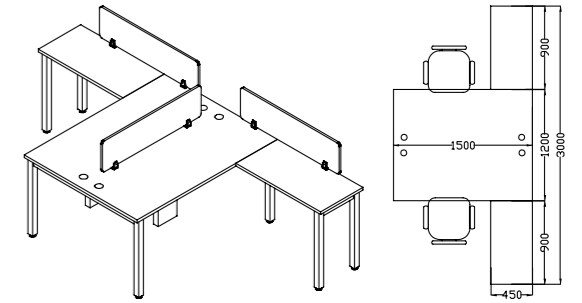

2 Seater
Main: 1500x600 | Return: 900x450

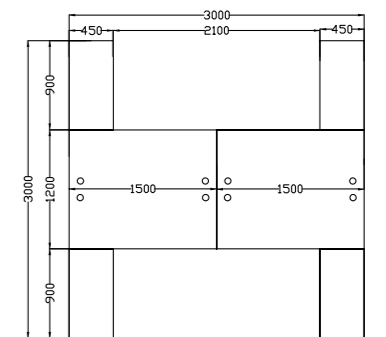
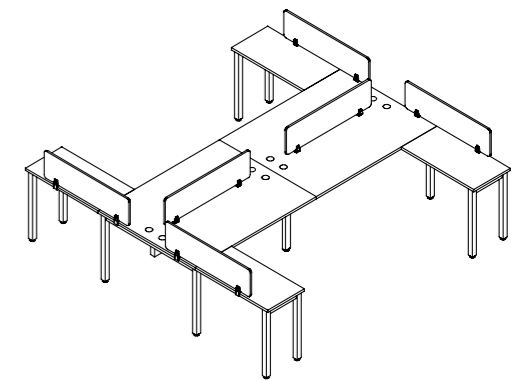
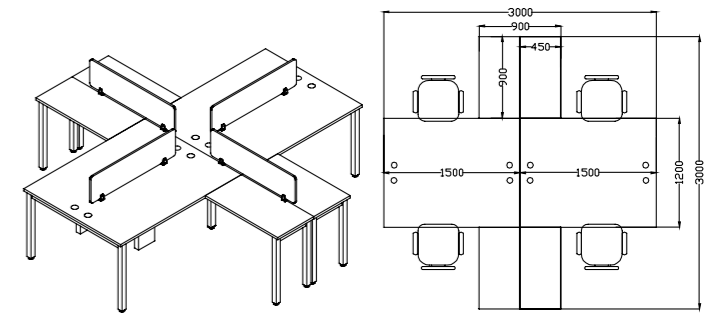

4 Seater
Main: 3000x3000 | Return: 900x450

L - Shape

Non Sharing Cluster

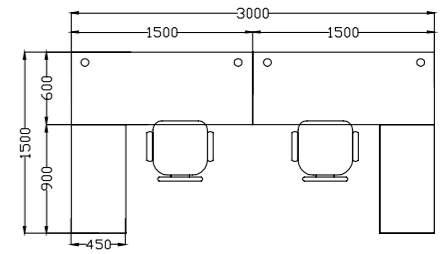
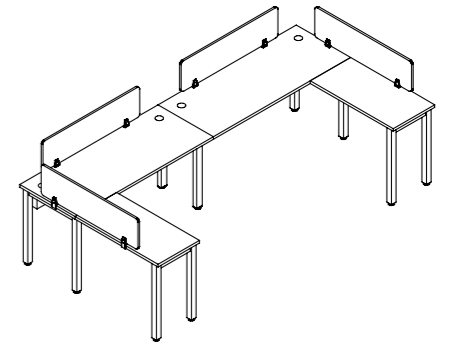

2 Seater (a)
Main: 3000x1500 | Return: 900x450

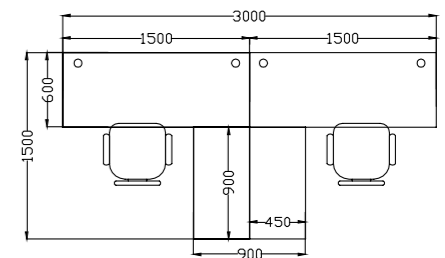
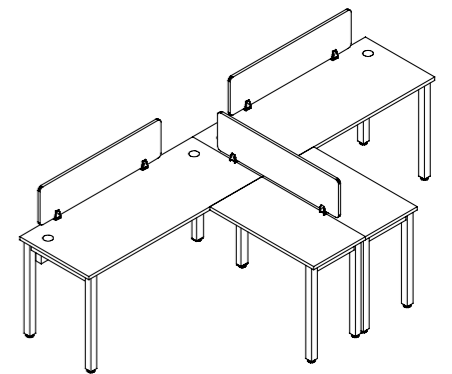

2 Seater (b)
Main: 3000x1500 | Return: 900x450

Meeting Table



Discussion Table

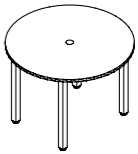

1050 Dia

Conference Tables

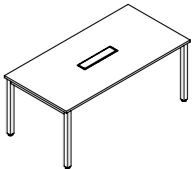

1800x900

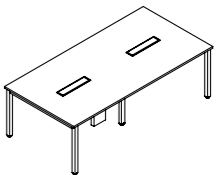

2400x1200

Ideas

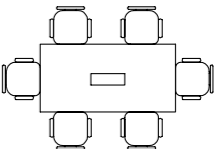

6-8 Seater 1800x900

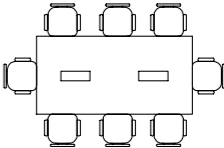

8-10 Seater 2400x1200

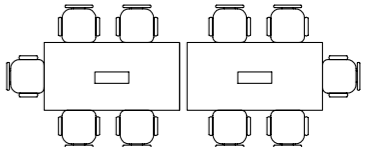

10-12 Seater 3600x900

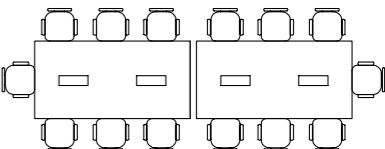

14-16 Seater 4800x1200

Training Table



Training/ Multi Purpose Tables
(Converting individual tables to conference mode)

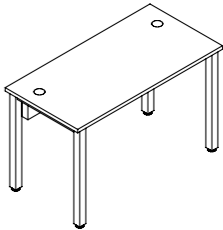

1200x600 / 1500x600

Ideas

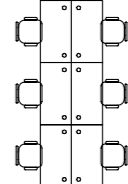

T1

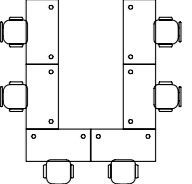

T2

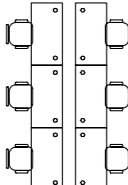

T3

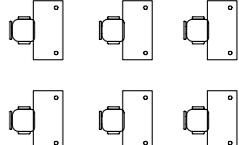

T4

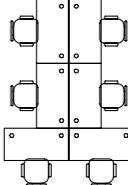

T5

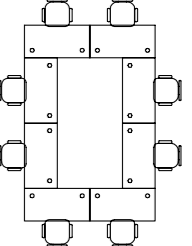

T6

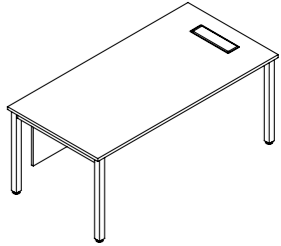

ET 1

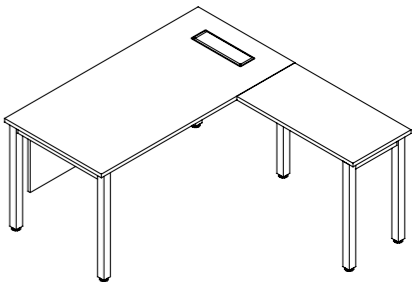

ET 2

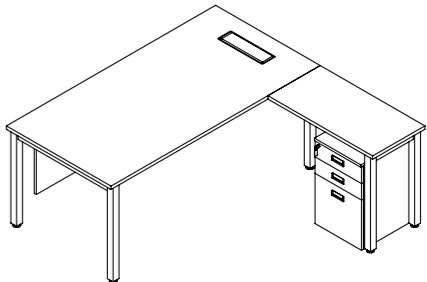

ET 3

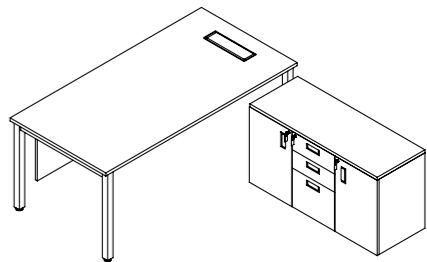

ET 4

Main: 1500x750x750HT / 1800x900x750HT
 Return: 900x450x750HT / Storage: 1200x450x640HT

Storages



Storages

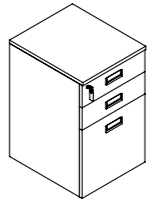

Pedestal
400Wx450Dx640HT

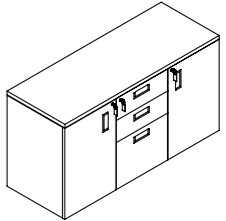

Side Unit
1200Wx450Dx640HT

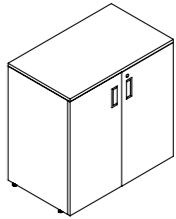

Storage 750
750Wx450Dx750HT

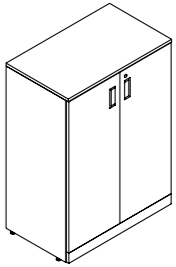

Storage 1200
750Wx450Dx1200HT

Ideas

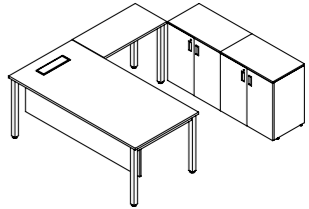

ET 5

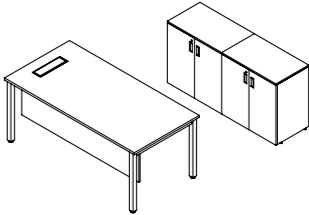

ET 6

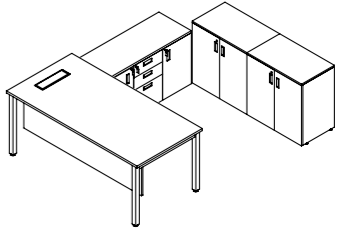

ET 7

Technical Specifications

Workstations

Table Top
25mm thick pre laminated particle board with 2mm edge banding.

Leg/ Under structure
50x50mm powdercoated MS square leg with 40x20mm MS cross beams.

Screen(1050w x 300ht)
a) Fabric Magnetic Screen: 12mm thick MDF clad with fabric and mounted on powdercoated studs.

b) Glass Screen: 8mm thick glass screen (Laminated colored glass) and mounted on powdercoated studs.

Wire Management
65mm dia wire manager hole and 125mm height metal raceway below for wire management with standard cutouts (ROMA) 8 module + data socket.

Cabin Tables

Table Top
25mm thick pre laminated particle board with 2mm edge banding.

Leg/ Under structure
50x50mm powdercoated MS square leg with 40x20mm MS beams.

Wire Management
Aluminium flip open and PVC cable tray below for wire management.

Modesty Panel
450mm height, 18mm thick pre laminated modesty panel mounted with aluminium bracket.

Accessories

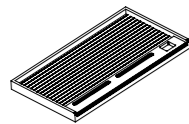

ABS Keyboard Tray
Without Mouse Pad

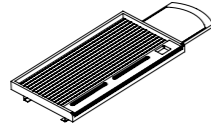

ABS Keyboard Tray
With Mouse Pad

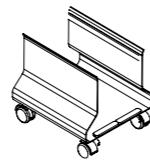

CPU Trolley



Accessory Rail

Paper Tray

Pencil Stand

Stationary Tray

Wire Management

Vertical Wire Entry Cover

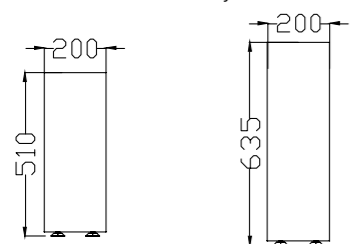

For
Workstations

For Cabins &
Meeting Tables



Vertebra
Colour: Silver Grey

Switch Mounting Provision on Raceway for Workstations

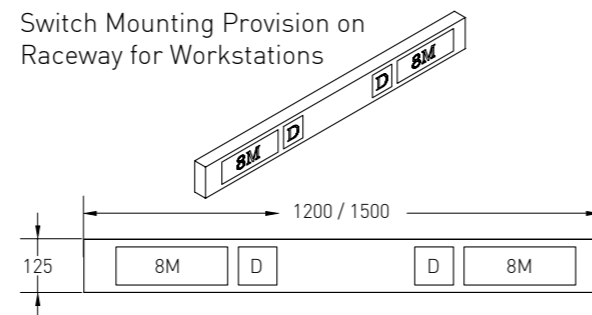

Cutout Details (Standard Anchor Roma)

Finishes

Fabric Shades for Fabric Magnetic Screens

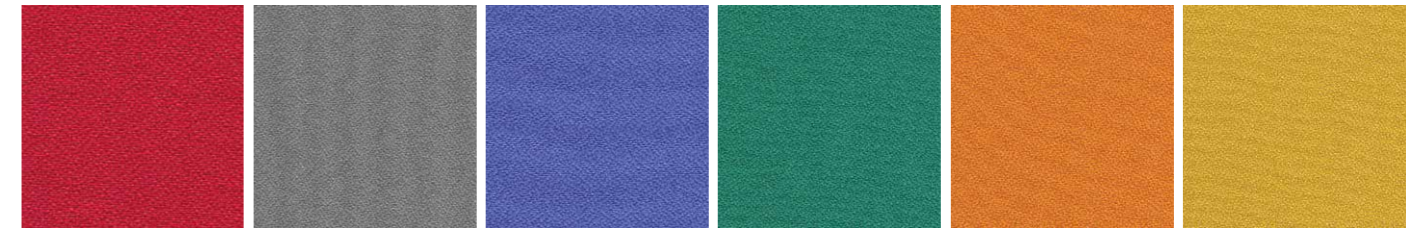

Red- F123

Grey- F126

Blue- F191

Green- F116

Orange- F181

Lemon- F151

Glass for 8mm Thick Coloured Glass Screens



Green

Yellow

White

Pre Lam Board for Table tops, Pedestal and Storages

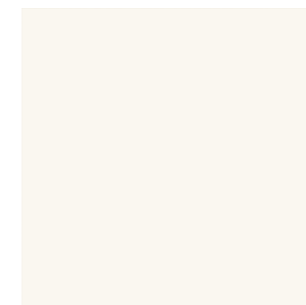

Everest White



Tanasu maple



Warm Grey

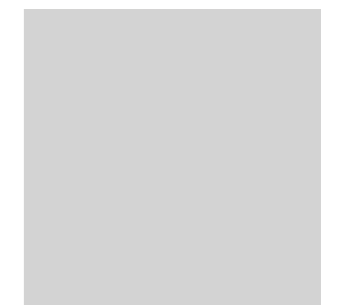

Textured Moon Light Grey

Pre Lam Board for Pedestal & Storage Facia

Powder Coating (All metal items)

Flip Up - Anodised Aluminium Flip Up Cover



Aluminium Flip-ups are available in 2 sizes depending on the number of switches required. The design is brushless and gasket free with openings for wires on three sides to ensure the least clutter and neatest aesthetic. The Aluminium Flip-up comes with a soft close mechanism.

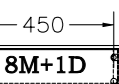
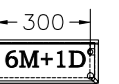

Sizes:
300mm - 6 module + data port (for Cabin Tables)
450mm - 8 module + data port (for Meeting Tables)

In view of continuous development and improvement, the dimensions and specifications may be changed without prior notice or obligations. All the dimensions are in mm. Accessories shown in the photograph are not part of the standard product. Colour options depicted in this catalogue are as close as possible to what modern printing process allow.

FEATHERLITE OFFICE SYSTEMS (P) LTD.

16/A, Millers Road, Vasanthnagar, Bangalore - 560 052

Tel: 080-4020 9631-637 | e-mail: sales@featherlitefurniture.com

www.featherlitefurniture.com

SHOWROOMS

Bangalore (Vasanth Nagar)	080-40209631	93424 55502
B'lore (Bannerghatta)	080-26481232	87626 89449
B'lore (Marathahalli)	080-42099068	96202 20217
Ahmedabad	079-30071300	82380 32300
Ananthpur	08554-239020	94402 90233
Bhubaneswar	0674-2354131	77357 30250
Chandigarh		98766 71147
Chennai (Egmore)	044-28274757	98844 54784
Chennai (Haddows Road)	044-28232764	98844 01380
Chennai (Nandanam)	044-24327129	98422 20127
Coimbatore	0422-4357129	98422 20129
Davangere	08192-233564	99005 50099
Durgapur		98365 57900
Ernakulam	0484-2370440	94960 75508
Goa	0832-2781111	72760 34119
Guwahati	0361-2466235	94350 36547
Hubli		99007 72211
Hyderabad (Somajiguda)	040-23374045	77999 25009
Hyderabad (Gachibowli)	040-40066272	98855 07050
Imphal (manipur)	0385-2446918	87947 32106
Indore	0731-4000566	74157 75000
Jaipur	0141-2604189	99501 45104
Jamshedpur	0657-2320370	94315 24051
Kochi	0484-2776935	93886 81284
Kolkata	033-40702034	98307 74009
Kolhapur	0231-2640917	93711 11878
Kurnool	08518-257333	94402 90233
Ludhiana	0161-5065091	98766 71147
Lucknow	0522-4009973	99183 02012
Mangalore	0824-2425041	98801 88169
Manipur	0385-2446918	98638 88999
Madurai	0452-2629898	88708 22228
Mumbai (Lower Parel)	022-66399192/93	80802 22339
Mysore	0821-4257220	97393 88080
Nagpur	0712-2446214	90280 17311
Nellore		85009 64999
New Delhi	011-40638000	98109 14484
New Delhi (M.G. Road)	011-41622861/62	99990 62766
Noida	0120-4562364	95602 22011
Patna	0612-2270748	90310 22875
Pune	020-66012818	96650 55552
Rajkot	0281-2466055	93774 67219
Ranchi	0651-2532667	90310 22875
Raipur	0771-6054009	94255 03309
Salem	0427-4552323	98943 55232
Secunderabad	040-27802602	98666 33048
Shimoga	08182-279441	99005 50099
Siliguri		90022 63263
Thiruvananthapuram		93886 81284
Tinsukia	0374-2331161	94350 36546
Tirupathi	0877-2281977	98661 48909
Vadodra		98240 03041
Vijayawada	0866-3042076	86864 66466
Vishakapatnam	0891-2530770	93463 30770

Now Available Online on
store.featherlitefurniture.com

INTERNATIONAL SHOWROOMS/ OFFICES

Kathmandu, Nepal	977-16200209	+977 98020 44440
Colombo, Srilanka		+94 7777 63973
Dubai, U.A.E.		+971 55101 4506



Wood from 3rd party certified for environmentally and socially responsible forestry management.

