



Shakti Hormann
Doors for Home and Industry

NEW



ED **EZDOOR**
CONTRACT SERIES

HÖRMANN

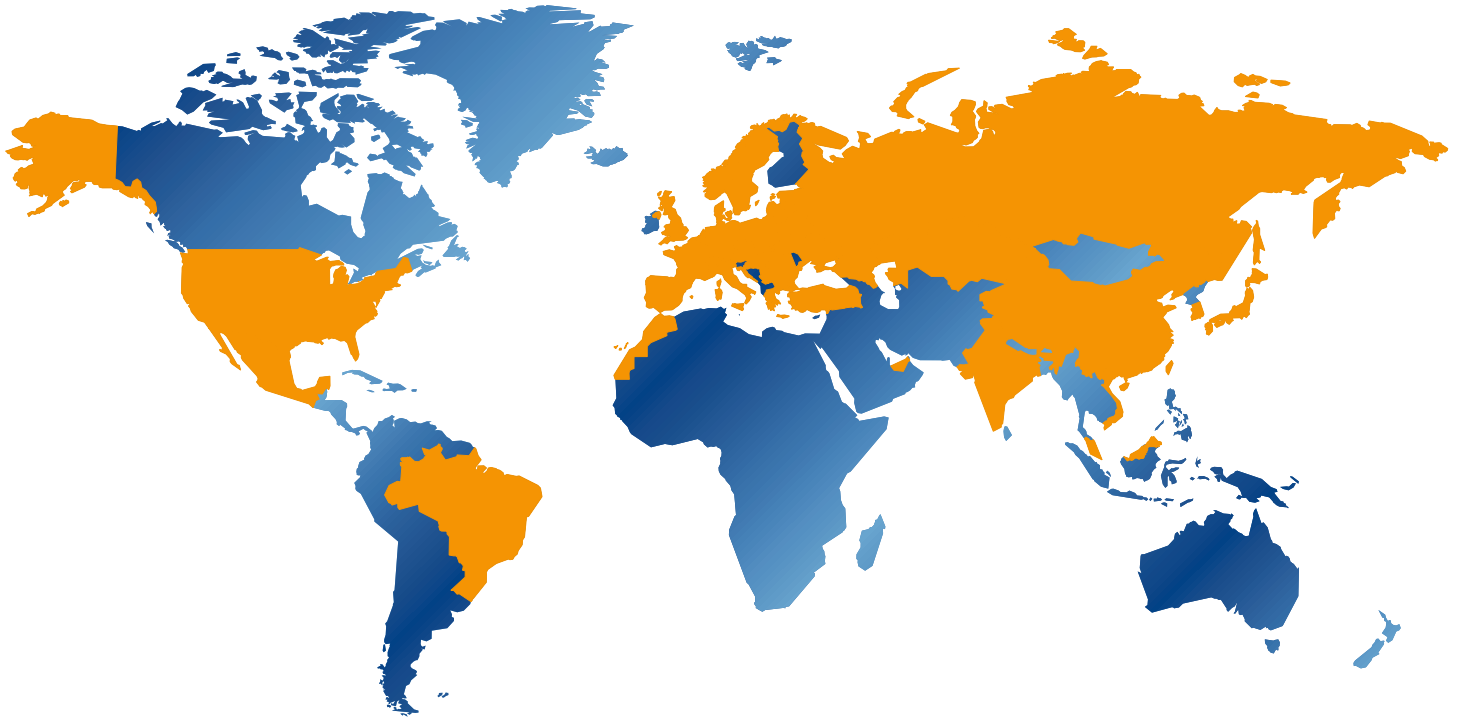

Austria
Belarus
Belgium
Brazil
Bulgaria
China
Croatia
Czech Republic
Denmark
Estonia
France
Germany
Great Britain
Greece

Hong Kong
Hungary
India
Italy
Japan
Kazakhstan
Korea
Lithuania
Malaysia
Mexico
Middle East
Morocco
Netherlands

Norway
Poland
Portugal
Romania
Russia
Serbia
Slovakia
Spain
Sweden
Switzerland
Turkey
Ukraine
USA
Vietnam



Ez - Contract series

ED EZDOOR

CONTRACT SERIES

Choose from a pre-selected range of standard doors and receive your high performance Hormann doors faster than ever before.

BENEFITS TO THE BUYER

- 100% tested and compliant fire door as per NBC 2016
- Labeled doors tested and certified by CBRI Roorkee.
- Standard sizes for ease of selection.
- Standard hardware options covering common applications.
- Five years warranty against manufacturing defects.
- Complete package of door and hardware in one box
- Easy to handle, store and install
- Choice of RAL colors

All warranties are subject to manufacturer's terms and conditions of supply and installation.

Please refer the terms of supply and installation for further details.

PLACE YOUR ORDER IN 3 EASY STEPS

- 
1 Select your door and hardware configuration
- 
2 Book your order through our partner
- 
3 Make your payment





Colour

Standard colours



Traffic Red

RAL 3020 (01)

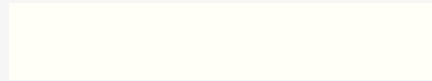

Pure White

RAL 9010 (04)



Window Grey

RAL 7040 (06)

* These colours are for illustration only. Please refer to paint chips for colour matching.

Handing

Application

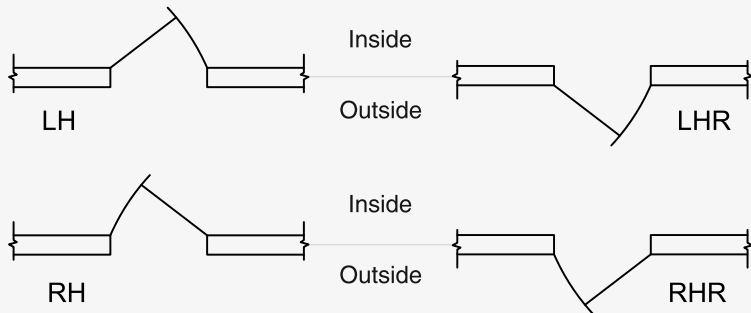

- Exit staircase
- Utility doors
- Corridors
- Shafts
- Others

Joinery Details

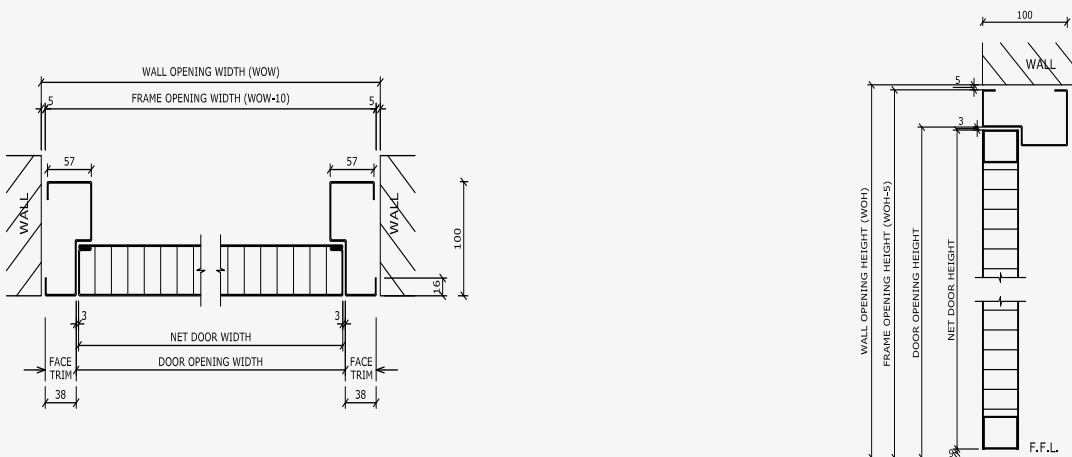

Fire Doors

FD120

Material	Galvanised steel
Shutter	46mm
Profile	100 x 57mm
Rebate stop	19mm
Profile type	Non-grooved
Assembly	Mitered
Infil	Honeycomb
Undercut	9mm

Wall Opening Sizes (WOW X WOH)

- 1000 x 2100
- 1200 x 2100
- 1000 x 2400
- 1200 x 2400

Glass Dimensions

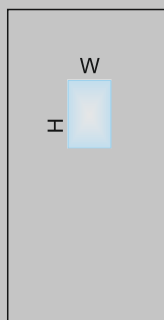

Vision panel 200 X 300

Wall Opening Sizes (WOW X WOH)

- 1000 x 2100
- 1200 x 2100
- 1000 x 2400
- 1200 x 2400



Note:- *All Dimensions are in mm

Mortise Sash Lock

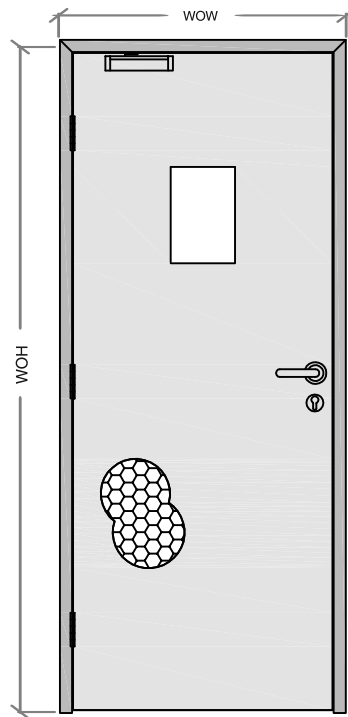

Hardware Set - A1 (2100)

Material Description	Finish
Ball bearing butt hinge, 4330, SS304 Size 100 x 75 x 3mm with screws in SSS – Hormann	SSS
Mortise sash lock H11 Hormann SSS	Silver
Euro profile 5 pin cylinder 5702, 70mm Key x Key, NP finish. - Hormann	NP
Lever handle LT001, 19 Dia with roses & Escutcheon SS304, SSS finish - Hormann	SSS
Door closer HDC03 EN 3 with std arm Silver - Hormann	Silver
Clear fire rated glass for 120min	Na
Gasket, Fire rated 4mm Thick x 13mm, Black	Na

* Hardware Set - A2 for 2400 mm height

Mortise Dead Lock

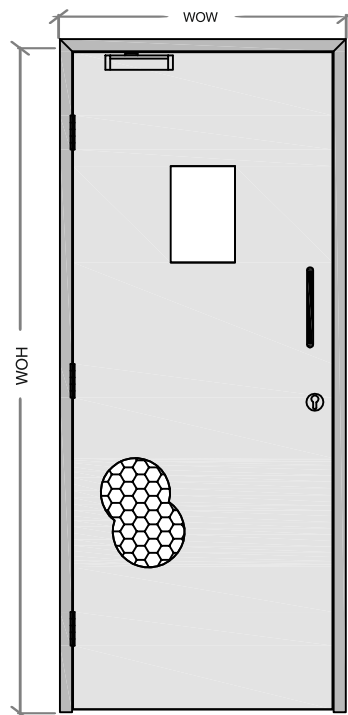

Hardware Set - B1 (2100)

Material Description	Finish
Ball bearing butt hinge, 4330, SS304 Size 100 x 75 x 3mm with screws in SSS – Hormann	SSS
Mortise Dead lock, H4, 55 BS/8mm, SSS finish - Hormann	Silver
Euro profile 5 pin cylinder 5702 70mm Key x Key, NP finish. - Hormann	NP
Escutcheon ES001 SSS for euro profile cylinder Hormann	SSS
Pull handle D type, D-25, L-300,C-300, B/B, 304 SSS - Hormann	SSS
Door closer HDC03 EN 3with std arm Silver - Hormann	Silver
Clear fire rated glass for 120min	Na
Gasket, Fire rated 4mm Thick x 13mm, Black	Na

* Hardware Set - B2 for 2400 mm height

WOW = Wall Opening Width
WOH = Wall Opening Height

Fire Doors

FD120

Material	Galvanised steel
Shutter	46mm
Profile	100 x 57mm
Rebate stop	19mm
Profile type	Non-grooved
Assembly	Mitered
Infil	Honeycomb
Undercut	9mm

Wall Opening Sizes (WOW X WOH)

- 1000 x 2100
- 1200 x 2100
- 1000 x 2400
- 1200 x 2400

Glass Dimensions

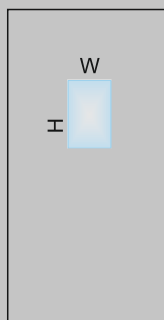

Vision panel 200 X 300

Wall Opening Sizes (WOW X WOH)

- 750 x 1500
- 900 x 1500
- 750 x 1800
- 900 x 1800



Note:- *All Dimensions are in mm

Panic Device

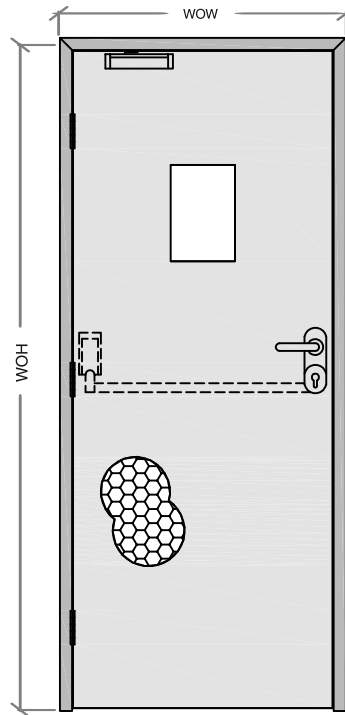

Hardware Set - C1 (2100)

Material Description	Finish
Ball bearing butt hinge, 4330, SS304 Size 100 x 75 x 3mm with screws in SSS - Hormann	SSS
Single point surface panic latch XDB5760SV, L=1100mm, Silver finish - Hormann	Silver
External lever handle, 1185, with euro profile cylinder Silver Finish- Hormann	SSS
Door closer HDC03 EN 3 with std arm Silver - Hormann	Silver
Clear fire rated glass for 120min	Na
Gasket, Fire rated 4mm Thick x 13mm, Black	Na

* Hardware Set - C2 for 2400 mm height

Shaft lock

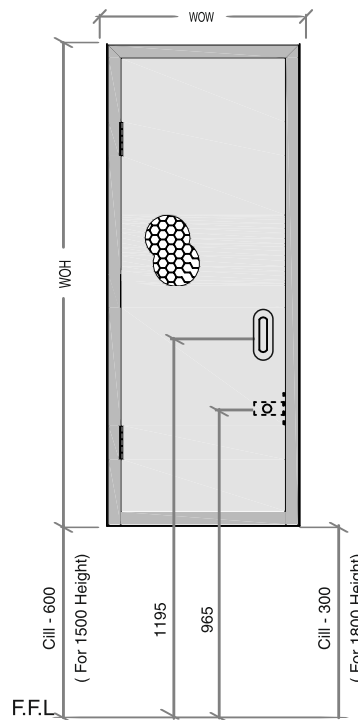

Hardware Set - D1 (1500)

Material Description	Finish
Ball bearing butt hinge, 4330, SS304 Size 100 x 75 x 3mm with screws in SSS - Hormann	SSS
Mortise shaft dead lock H7, 57mm with allen key SSS - Hormann	SSS
Flush handle CH 120S, 120mmx40mm, Rectangular, SSS - Guardian / Hormann	NP

* Hardware Set - D1 for 1800mm height

WOW = Wall Opening Width
WOH = Wall Opening Height



Multipurpose Doors

Mortise Sash Lock

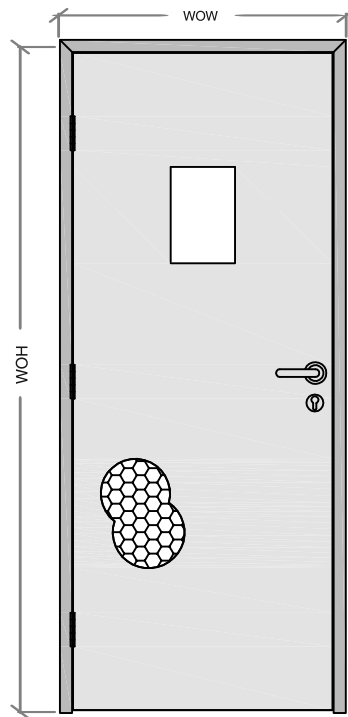

Hardware Set - A3 (2100)

Material Description	Finish
Ball bearing butt hinge, 4330, SS304 Size 100 x 75 x 3mm with screws in SSS – Hormann	SSS
Mortise sash lock H11 Hormann SSS	Silver
Euro profile 5 pin cylinder 5702, 70mm Key x Key, NP finish. - Hormann	NP
Lever handle LT001, 19 Dia with roses & Escutcheon SS304, SSS finish - Hormann	SSS
Clear float glass - 5mm	Na
Gasket, Foam tape single side adhesive 4mm thick x 12.5mm, black	Na

* Hardware Set - A4 for 2400 mm height

Mortise Dead Lock

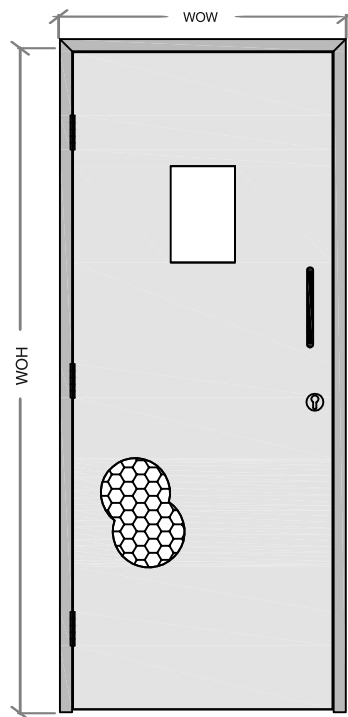

Hardware Set - B3 (2100)

Material Description	Finish
Ball bearing butt hinge, 4330, SS304 Size 100 x 75 x 3mm with screws in SSS – Hormann	SSS
Mortise Dead lock, H4, 55 BS/8mm SSS finish - Hormann	Silver
Euro profile 5 pin cylinder 5702 70mm Key x Key, NP finish. - Hormann	NP
Escutcheon ES001 SSS for euro profile cylinder Hormann	SSS
Pull handle D type, D-25, L-300, C-300, B/B, 304 SSS - Hormann	SSS
Clear float glass - 5mm	Na
Gasket, Foam tape single side adhesive 4mm thick x 12.5mm, black	Na

* Hardware Set - B4 for 2400 mm height

WOW = Wall Opening Width
WOH = Wall Opening Height

Material	Galvanised steel
Shutter	46mm
Profile	100 x 57mm
Rebate stop	19mm
Profile type	Non-grooved
Assembly	Mitered
Infil	Honeycomb
Undercut	9mm

Wall Opening Sizes (WOW X WOH)

- 1000 x 2100
- 1200 x 2100
- 1000 x 2400
- 1200 x 2400

Glass Dimensions

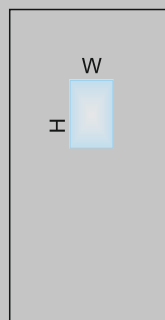

Vision panel 200 X 300

Wall Opening Sizes (WOW X WOH)

- 1000 x 2100
- 1200 x 2100
- 1000 x 2400
- 1200 x 2400

Note:- *All Dimensions are in mm



Multipurpose Doors

Panic Device

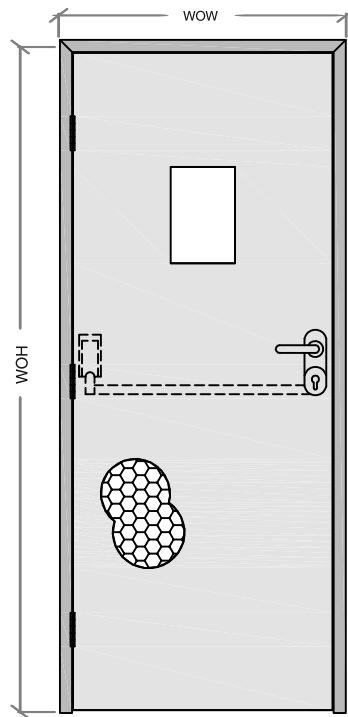

Hardware Set - C3 (2100)

Material Description	Finish
Ball bearing butt hinge, 4330, SS304 Size 100 x 75 x 3mm with screws in SSS - Hormann	SSS
Single point surface panic latch XDB5760SV, L=1100mm, Silver finish - Hormann	Silver
External lever handle, 1185, with euro profile cylinder, Silver Finish- Hormann	SSS
Clear float glass - 5mm	Na
Gasket, Foam tape single side adhesive 4mm thick x 12.5mm, black	Na

* Hardware Set - C4 for 2400 mm height

Material	Galvanised steel
Shutter	46mm
Profile	100 x 57mm
Rebate stop	19mm
Profile type	Non-grooved
Assembly	Mitered
Infil	Honeycomb
Undercut	9mm

Wall Opening Sizes (WOW X WOH)

- 1000 x 2100
- 1200 x 2100
- 1000 x 2400
- 1200 x 2400

Glass Dimensions

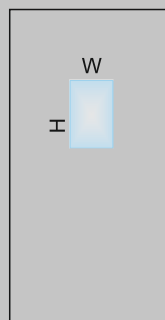

Vision panel 200 X 300

Wall Opening Sizes (WOW X WOH)

- 750 x 1500
- 900 x 1500
- 750 x 1800
- 900 x 1800

Shaft lock

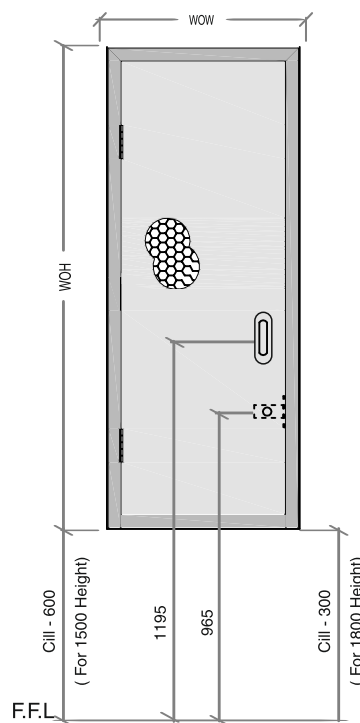

Hardware Set - D1 (1500)

Material Description	Finish
Ball bearing butt hinge, 4330, SS304 Size 100 x 75 x 3mm with screws in SSS - Hormann	SSS
Mortise shaft dead lock H7, 57mm with allen key SSS - Hormann	SSS
Flush handle CH 120S, 120mmx40mm, Rectangular, SSS - Guardian / Hormann	NP

* Hardware Set - D1 for 1800mm height

WOW = Wall Opening Width
WOH = Wall Opening Height

Note:- *All Dimensions are in mm



Stainless Steel Ball Bearing
Butt Hinge 4x3x3mm



Mortise sash lock H11
Hormann SSS



Mortise Deadbolt H4
BS 55 mm

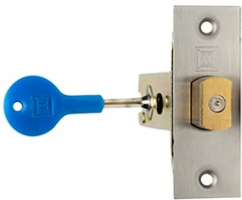

Mortise Shaft Lock H7
BS - 57 mm



Panic Device XDB 5760 SV
Single Point



Euro Profile Cylinder
with Both Side Key



Stainless Steel
Lever Handle Lt001



D Type Handle



Recessed Handle



Panic device External Trim



Door Closer HDC03
EN 3



Escutcheon ES 001



Order Format

Choose your requirement

1 Door type

FD - Fire door
MPD - General door

2 WO size std door

1021 - 1000 x 2100
1221 - 1200 x 2100
1024 - 1000 x 2400
1224 - 1200 x 2400

3 WO size shaft door

7515 - 750 x 1500
9015 - 900 x 1500
7518 - 750 x 1800
9018 - 900 x 1800

4 Hardware set

	<u>FD</u>		<u>MPD</u>	
	2100	2400	2100	2400
Mortise sash lock	A1	A2	A3	A4
Mortise dead lock	B1	B2	B3	B4
Panic device	C1	C2	C3	C4
Shaft lock	D1	D1	D1	D1

5 Vision Panel

00 - Without vision panel
01 - With vision panel

6 Handing

11 - Right Hand (RH)
12 - Left Hand (LH)
13 - Right hand reverse (RHR)
14 - Left hand reverse (LHR)

7 Colour

Standard
01 - RAL 3020
02 - RAL 9001
Optional (on request)
03 - RAL 5023
04 - RAL 9010
05 - RAL 7035
06 - RAL 7040
07 - RAL 9016
08 - RAL 8017

Note: all panic device & shaft door
handing will be either LHR/RHR

Example: if you want a fire door of size 1200 x 2400mm, with panic device and vision panel handing left hand reverse in RAL 3020 you can order either by giving the product code or SAP reference

Product code shall be - FD-1224-C2-01-LHR-01 & the quantity

Order form

							(INR)
S.no	Product Code	Handing	Colour	SAP code	Qty	Unit Rate	Total
1	FD1224C201	14	01				

Total qty / Basic value

Packing

Transportation

GST @ 18% on basic value, packing & transportation
(or as applicable at the time of dispatch)

Grand total in INR

Ship to:

Bill to:

GSTN No:



Hörmann: Quality without compromise



Hörmann KG Amshausen, Germany



Hörmann KG Antriebstechnik, Germany



Hörmann KG Brandis, Germany



Hörmann KG Brockhagen, Germany



Hörmann KG Dissen, Germany



Hörmann KG Eckelhausen, Germany



Hörmann KG Freisen, Germany



Hörmann KG Ichttershausen, Germany



Hörmann KG Werne, Germany



Hörmann Alkmaar B.V., Netherlands



Hörmann Legnica Sp. z o.o., Poland



Hörmann Beijing, China



Hörmann Tianjin, China



Hörmann LLC, Montgomery IL, USA



Hörmann Flexon LLC, Burgettstown PA, USA



Shakti Hormann, India



- GARAGE DOORS
- OPERATORS
- INDUSTRIAL DOORS
- LOADING EQUIPMENT
- HINGED DOORS
- DOOR FRAMES



Shakti Hormann Pvt. Ltd.
 Plot No. 20, Sripuri Colony, Karkhana, Secunderabad - 500 015
 Telangana India
 T: +91 40 2784 0394/5 F: +91 40 2789 2327
 E: sales@shaktihormann.com
 www.shaktihormann.com



Platinum Rated Green Facility

